



Dräger X-am 2500 (MQG 0011) Technical Manual

Content

1	For Your Safety	4	6	Operation with pump	21
1.1	General safety statements	4	7	Replacing the sensors	21
1.2	Definitions of alert icons	4	8	Troubleshooting	22
2	Description	5	8.1	Warning messages	22
2.1	Product overview	5	8.2	Fault messages	24
2.1.1	Front	5	9	Maintenance	27
2.1.2	Rear side	5	9.1	Maintenance table	27
2.1.3	Display	5	9.2	Cleaning	27
2.1.4	Special symbols	5	10	Disposal	27
2.2	Intended use	6	10.1	WEEE	27
2.3	Approvals	6	10.2	Battery disposal	27
2.3.1	Marking	6	10.3	Electrochemical sensors	27
2.3.2	Permitted power packs	6	11	Technical data	28
2.3.3	Safety Instructions	7	11.1	X-am 2500	28
3	Use	8	11.2	Sensor Data	29
3.1	Preparations for use	8	12	Order list	31
3.1.1	Charging the batteries	8	13	Declaration of Conformity	32
3.1.2	Replacing the batteries / rechargeable batteries ..	9			
3.1.3	Switching on the instrument	9			
3.1.4	Switching off the instrument	10			
3.2	Before entering the workplace	10			
3.3	Configuration	11			
3.3.1	Standard gas configuration	11			
3.3.2	Standard instrument configuration	12			
3.3.3	Configuring the device	12			
3.3.4	Export data memory and display graphically	12			
3.4	Running the bump test	13			
3.4.1	Manual implementation without documentation of the results in the instrument memory	13			
3.4.2	Menu implementation with the documentation of results in the instrument memory	13			
3.4.3	Automatic implementation with the Bump Test Station	14			
3.5	During use	14			
3.6	Identifying alarms	15			
3.6.1	Concentration pre-alarm A1	15			
3.6.2	Concentration main alarm A2	15			
3.6.3	STEL / TWA exposure alarm	15			
3.6.4	Battery pre-alarm	15			
3.6.5	Battery main alarm	15			
3.6.6	Instrument alarm	15			
4	Menu functions	16			
4.1	Activating the Info mode	16			
4.2	Opening Info-Off Mode	16			
4.3	Quick Menu	16			
4.3.1	Quick menu functions	16			
4.3.2	Opening the Quick Menu	16			
4.3.3	Quick menu "Displaying and deleting peak values" ..	16			
4.4	Calibration Menu	16			
4.4.1	Calibration menu functions	16			
4.4.2	Open the Calibration Menu	16			
5	Calibrate instrument	17			
5.1	Adjustment interval:	17			
5.2	Run fresh air calibration	17			
5.3	1-button calibration	18			
5.3.1	Calibrating the sensitivity for an individual measuring channel	19			
5.3.2	Sensitivity calibration for CatEx	19			

1 For Your Safety

1.1 General safety statements

- Before using this product, carefully read the associated Instructions for Use. This document does not replace the Instructions for Use.

1.2 Definitions of alert icons

The following alert icons are used in this document to provide and highlight areas of the associated text that require a greater awareness by the user. A definition of the meaning of each icon is as follows:



WARNING

Indicates a potentially hazardous situation which, if not avoided, could result in death or serious injury.



CAUTION

Indicates a potentially hazardous situation which, if not avoided, could result in physical injury, or damage to the product or environment. It may also be used to alert against unsafe practices.



NOTICE

Indicates additional information on how to use the product.

2 Description

2.1 Product overview

2.1.1 Front

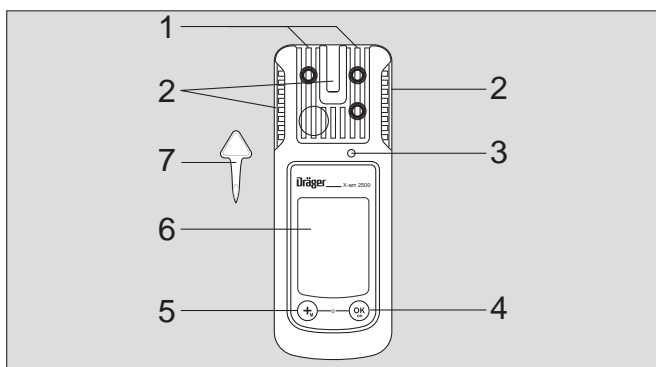

00133366.eps

- 1 Gas entry
- 2 Alarm LED
- 3 Horn
- 4 key
- 5 key
- 6 Display
- 7 Tool for changing sensor

2.1.2 Rear side

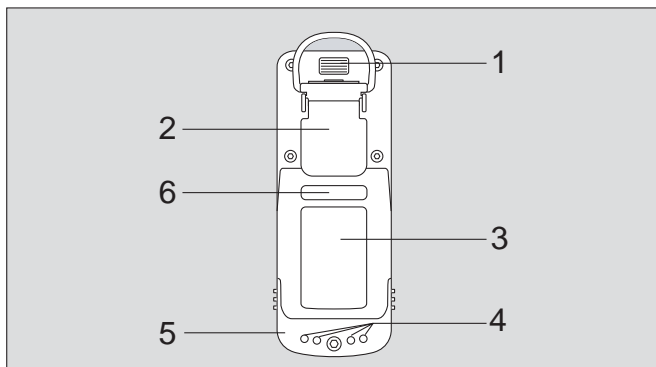

00233366.eps

- 1 IR interface
- 2 Fastening clip
- 3 Nameplate
- 4 Charging contacts
- 5 Power pack
- 6 Serial no.

2.1.3 Display

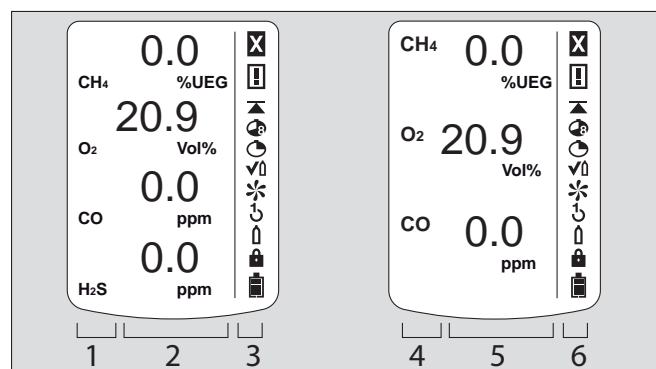

00333366_de.eps

Display for 4 measuring channels:

- 1 Measured gas display with unit
- 2 Measuring value display
- 3 Special symbols

otherwise:

- 4 Measured gas display
- 5 Measured value display with unit
- 6 Special symbols

The following only shows the instrument version with 4 measuring channels.

2.1.4 Special symbols

- Fault message, see section 4.1 on page 16
- Warning message, see section 4.1 on page 16
- Display of peak values for all measured gases, see section 4.1 on page 16
- The exposure evaluation display (TWA) for measured gases, e.g. H₂S and CO, see section 4.1 on page 16
- The exposure evaluation display (STEL) for measured gases, e.g. H₂S und CO, see section 4.1 on page 16
- The instrument is set to the bump test function, see section 3.4 on page 13
- The instrument is set to the fresh air calibration function, see section 5.2 on page 17
- The instrument is set to the 1-button calibration/adjustment function, see section 5.3 on page 18
- The instrument is set to the single gas calibration function, see section 5.3.1 on page 19
- Function for password input is active, see section 4.4 on page 16
- Battery / rechargeable battery 100 % full
- Battery / rechargeable battery 2/3 full
- Battery / rechargeable battery 1/3 full
- Battery / rechargeable battery empty

2.2 Intended use

Portable gas detection instrument for the continuous monitoring of the concentration of several gases in the ambient air within the working area and in explosion-hazard areas. Independent measurement of up to 4 gases, in accordance with the installed Dräger sensors.

Areas subject to explosion hazards, classified by zones

The instrument is intended for the use in areas that are at risk for explosions in Zone 0, Zone 1 or Zone 2 or in mines at risk due to black damp. It is intended for use within a temperature range of -20 °C to +50 °C, and for areas in which gases of explosion groups IIA, IIB or IIC and temperature class T3 or T4 (depending on the batteries and rechargeable battery) may be present. For zone 0, the temperature class is limited to T3. If used in mines, the instrument is only to be used in areas known to have a low risk of mechanical impact.

Areas subject to explosion hazards, classified by divisions

The instrument is intended for the use in areas that are at risk for explosions of Class I&II, Div. 1 or Div. 2. It is intended for use within a temperature range of -20 °C to +50 °C, and for areas in which gases or dusts of groups A, B, C, D or E, F, G, and temperature class T3 or T4 (depending on the batteries and rechargeable battery) may be present.

2.3 Approvals

CE marking: Electromagnetic compatibility
(Directive 2004/108/EC)
Explosion protection (Directive 94/9/
EEC)

2.3.1 Marking

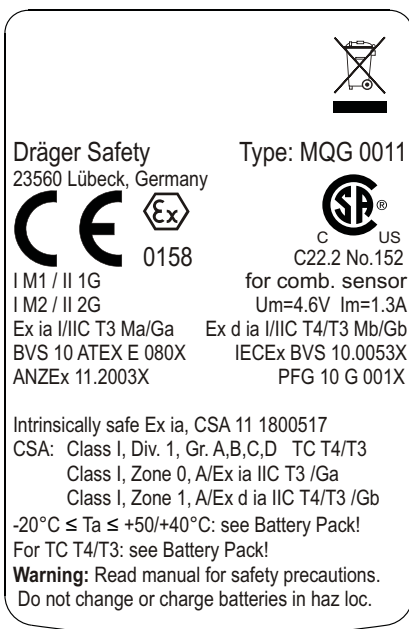

Serial no.¹ on separate sticker

¹ The year of construction is coded by the third capital letter of the serial number: D = 2012, E = 2013, F = 2014, H = 2015, J = 2016, K = 2017, L = 2018, etc.
Example: Serial number AREH-0054, the third letter is E, so the year of manufacture is 2013.

2.3.2 Permitted power packs

Power pack 83 22 237; approved as type ABT 0100

Temperature class T4
-20 °C ≤ Ta ≤ +50 °C
use with alkaline batteries
Duracell Procell MN1500²

Temperature class T3
-20 °C ≤ Ta ≤ +40 °C
use with NiMH rechargeable batteries
GP 180AAHC² (1800 mAh)

or with alkaline batteries
Varta Type 4006²
Varta Type 4106²
Panasonic LR6 Powerline

NiMH power pack T4 (order no. 83 18 704); approved as HBT 0000

Temperature class T4
-20 °C ≤ Ta ≤ +50 °C

NiMH power pack T4 HC (order no. 83 22 244); approved as HBT 0100

Temperature class T4
-20 °C ≤ Ta ≤ +50 °C

² Not subject to BVS10 ATEX E 080X and PFG 10 G 001X performance approval.

2.3.3 Safety Instructions



WARNING

Do not replace or charge batteries in potentially explosive areas. Explosion hazard!

Charge the NiMH power pack T4 (type HBT 0000) or T4 HC (type HBT 0100) with the associated Dräger charger. Charge NiMH single cells for ABT 0100 battery holder in accordance with the manufacturer's specifications. Ambient temperature during the charging process: 0 to +40 °C.

To reduce the danger of explosion, do not mix new batteries with old batteries and do not mix batteries made by different manufacturers.

Always disconnect the instrument from the power pack before carrying out any maintenance operations.

Substitution of components may impair intrinsic safety.

Only use power packs ABT 0100 (order no. 83 22 237), HBT 0000 (order no. 83 18 704) or HBT 0100 (order no. 83 22 244). See marking on power pack for approved batteries and related temperature classes.

Not tested in an oxygen-enriched atmosphere (>21 % O₂).

High off-scale readings may indicate an explosive concentration.



CAUTION

Re. CSA approval:

Before use each day, test the sensitivity using a known concentration of the gas being measured, corresponding to between 25 and 50 % of the maximum concentration. The accuracy must be in a range of 0 to +20 % of the actual value. Correct the accuracy via adjustment if necessary.

Only the functions of the part of the equipment used to measure flammable gases are measured as part of the CSA approval.

3 Use

3.1 Preparations for use

- Before using the instrument for the first time, insert the batteries provided or a charged NiMH power pack T4 (type HBT 0000; order no. 83 18 704) / T4 HC (type HBT 0100; order no. 83 22 244), see section 3.1.2 on page 9.
- The instrument is now ready for operation.

3.1.1 Charging the batteries



WARNING

Explosion hazard!
Do not charge underground or in explosion hazard areas!

The chargers are not designed in accordance with the regulations for fire damp and explosion protection.

Charge the NiMH power pack T4 (type HBT 0000) or T4 HC (type HBT 0100) with the associated Dräger charger. Charge NiMH single cells for ABT 0100 battery holder in accordance with the manufacturer's specifications. Ambient temperature during the charging process: 0 to +40 °C.



NOTICE

Even if the instrument is not used, Dräger recommends storing the instrument in the charging cradle (charging module X-am 1/2/5000, order no. 83 18 639).

- To maintain the lifetime of the batteries, charging is temperature controlled and only performed in a temperature range of 5 to 35 °C. When outside this temperature range, the charging automatically interrupted and automatically recommenced after the temperature range has been reached again.
- The charging time is typically 4 hours.
- A new NiMH power pack reaches its full capacity after three complete charging/discharging cycles.
- Never store the instrument for extended periods without being connected to a power source (maximum of 2 months) because the internal buffer battery will drain.

Charging with the multiple charging station

- A maximum of 20 instruments can be charged at the same time on the power pack (order no. 83 18 805) of the multiple charging station.
- When attaching the charging modules, disconnect the power pack from the mains supply!



CAUTION

Always connect or disconnect the charging modules individually and not in groups in order to prevent the charging station from becoming damaged. During transportation, the power pack and the charging modules should also always be handled individually and without inserted instruments.

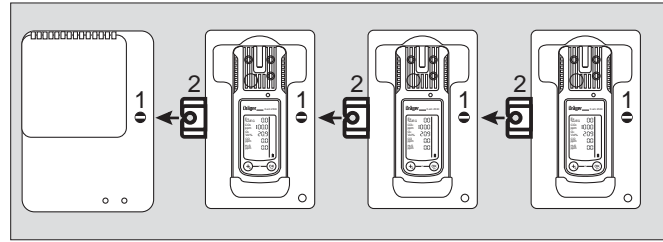

02733366.eps

- Position the instrument on an even and level surface.
- 1. Turn the slots of the interlock into a horizontal position by using a screwdriver or coin.
- 2. Insert the fastening lug (2) of the charger module (simultaneous power feed) until it engages.
- 3. Close the lock (1) with a quarter turn (slot is positioned vertically).
- 4. Attach additional charging modules in the same way.
- 5. Connect the power pack to the mains.
 - The green "Mains" LED (1) is on.
- 6. Insert the switched off instrument into the charging module.
 - Display LED (5) on the charging cradle:
 - ▬ Charging
 - ▬ Fault
 - ▬ Full
- If a fault occurs:
 - Remove the instrument from the charging module and insert it again.
- If the fault still occurs, have the charging module repaired.
 - It takes approx. 4 hours to fully charge an empty rechargeable battery.



CAUTION

A short circuit of the charging contacts in the charging modules, e. g., by metallic objects that have fallen in, does not result in damage to the charging station. It should, however, be avoided due to possible heating hazards and incorrect displays on the charger module.

- In the event of a short circuit or if the power pack is overloaded:
 - The red "Overload" LED (3) is on, and an audible alarm sounds.
 - After the fault has been corrected, the alarm is switched off automatically and the charging process is restarted.
 - In the event of a power failure, the instruments already charged will be protected from discharging.

Charge using charger module and plug-in power pack or vehicle charging adapter

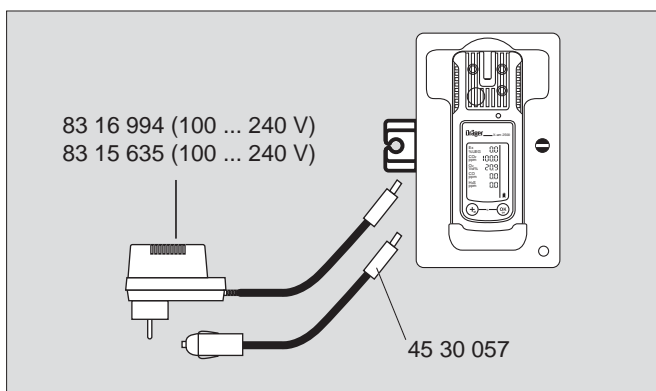

02833366.eps

- When using the power pack (order no. 83 16 994), up to 5 instruments can be charged at the same time, with power pack (order no. 83 15 635) up to 2 instruments.
- The power pack contained in the rechargeable battery and charging set (order no. 83 18 785) is suitable for charging one instrument.
- When using the vehicle charging adapter (order no. 45 30 057) it is recommended that you supply every charging module separately.
- The charging process is carried out analogous to charging with the multiple charging station.

3.1.2 Replacing the batteries / rechargeable batteries



WARNING

Explosion hazard!

Do not throw used batteries into fire or try to open them by force.

Do not replace or charge batteries in a hazardous area.

Batteries / rechargeable batteries are part of the Ex approval.

Only the following types may be used:

- Alkaline batteries – T3 – (non rechargeable!)
- Panasonic LR6 Powerline
- Varta Type 4106¹ (power one) or
- Varta Type 4006¹ (industrial)
- Alkaline batteries – T4 – (non rechargeable!)
- Duracell Procell MN1500¹
- NiMH rechargeable batteries – T3 – (rechargeable)
- GP 180AAHC¹ (1800 mAh) max. 40 °C ambient temperature.

Charge the NiMH power pack T4 (type HBT 0000) or T4 HC (type HBT 0100) with the associated Dräger charger. Charge NiMH rechargeable batteries for battery holder ABT 0100 in accordance with the manufacturer's specifications. Ambient temperature during the charging process: 0 to +40 °C.

1) Not part of the measurement performance tests BVS10 ATEX E 080X and PFG 10 G 001X.

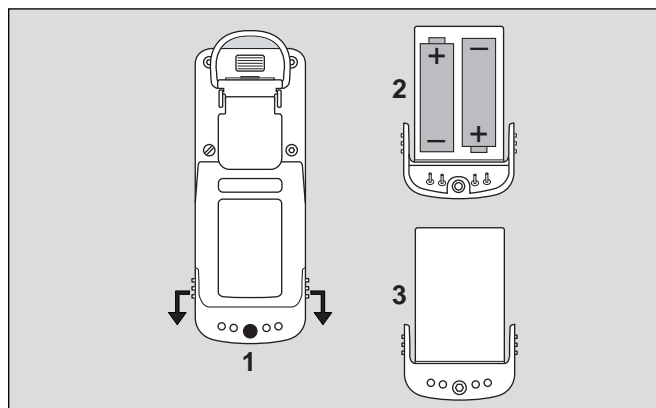

02633366.eps

1. Switching off the instrument: key and key are held down simultaneously.
2. Loosen the screw (2.0 mm hexagon socket) on the power pack and remove the power pack.
 - With battery holder (order no. 83 22 237): Replace alkaline batteries or NiMH rechargeable batteries. Ensure correct polarity.
 - With the T4 NiMH power pack (type HBT 0000) / T4 HC (type HBT 0100): Completely replace the power pack.
3. Insert the power pack into the instrument and tighten the screw, the instrument switches on automatically.

After replacing the T4 NiMH power pack (type HBT 0000)/ T4 HC (type HBT 0100), a full charge is recommended.

After the batteries have been replaced:

- The settings and data are stored when the battery is replaced. The sensors warm up again.

3.1.3 Switching on the instrument

1. **Hold down the [OK] button** for approx. 3 seconds until the » **3 . 2 . 1** « countdown shown on the display has elapsed.
 - All the display segments, including the visual, audible and vibration alarms, are activated for a short time.
 - The software version is displayed.
 - The instrument performs a self-test.
 - The sensor that is up next for calibration/adjustment is displayed with the remaining days until the next calibration/adjustment e. g. » **Ex %LEL CAL 20** «.
 - The time until the bump test interval elapses is displayed in days, e.g. » **bt 123** «.
 - All alarm thresholds A1 and A2 as well as » « (TWA)¹ and » « (STEL)³ for H₂S and CO are displayed consecutively.
 - During the warm-up period of the sensors, the respective display of the measured value flashes and the special symbol » « (for warning) is displayed. No alarms are issued during the warm-up period of the sensors. See the Technical Handbook for details regarding accelerated warm-up.
2. Press the **[OK]** key to cancel the display of the activation sequence.

1 Only when activated in the instrument configuration. Delivery status: not activated.

3.1.4 Switching off the instrument





- Press and hold the [OK] key and [+] key simultaneously until the countdown » 3 . 2 . 1 « shown on the display has elapsed.
Before the instrument is switched off, the visual, audible and vibration alarms are activated for a short time.

3.2 Before entering the workplace



WARNING

Before making safety-related measurements, check the adjustment and adjust as needed, and check all alarm elements. A bump test must be performed according to the national regulations.

1. Switch on the instrument. The current measured values are shown in the display.
2. Observe any warning »  « or fault messages »  «.
 -  The instrument can be operated normally. If the warning message does not disappear automatically during operation, the instrument must be serviced after the end of use.
 -  The instrument is not ready to measure and requires maintenance.



WARNING

Fractions of catalytic poisons in the measuring gas (e.g. volatile silicone, sulphur, heavy metal compounds or halogenated hydrocarbon) can damage the CatEx sensor. If the CatEx sensor can no longer be calibrated to the target concentration, the sensor must be replaced.

In case of measurements in an oxygen-deficient atmosphere (<8 Vol.-% O₂) the CatEx sensor may show incorrect displays; in this case, a reliable measurement with a CatEx sensor is not possible.

In an oxygen enriched atmosphere (>22 Vol.-% O₂), the electrical operational safety cannot be guaranteed; switch off instrument or leave work station.

3. Check that the gas inlet opening on the instrument is not covered.

3.3 Configuration

3.3.1 Standard gas configuration

DrägerSensor	Measuring range ¹⁾	Alarm A1 ¹⁾			Alarm A2 ¹⁾		
		threshold	can be acknowledged	self-latching	threshold	can be acknowledged	self-latching
CatEx 125 PR [%LEL]	0 to 100	20	yes	no	40	no	yes
XXS O ₂ [Vol.-%]	0 to 25	19 ²⁾	no	yes	23	no	yes
XXS CO [ppm]	0 to 2000	30	yes	no	60	no	yes
XXS H ₂ S LC [ppm]	0 to 100	1.6	yes	no	3.2	no	yes
XXS NO ₂ [ppm]	0 to 50	5	yes	no	10	no	yes
XXS SO ₂ [ppm]	0 to 100	1	yes	no	2	no	yes

1) Different settings can be selected to meet customer requirements on delivery. The current setting can be checked and changed with the Dräger CC Vision software.

A version of the CC-Vision software that can be used for Dräger X-am 2500 is available for download from the product page for the X-am 2500 at the following web address: www.draeger.com

2) With O₂, A1 is the lower alarm threshold: an alarm is triggered if the value is too low.

3.3.2 Standard instrument configuration

Bump test in Quick Menu ¹⁾	Quick bump test
Fresh air calibration in the Quick Menu ¹⁾	ON
Life sign - visual only ¹⁾	ON
Switching off ¹⁾	allowed
LEL factor ¹⁾ (CH ₄)	4.4 (vol. %) (4.4 vol. % corresponds to 100 %LEL)
Averaging time ¹⁾	15 minutes for STEL 8 hours for TWA

1) Different settings can be selected to meet customer requirements on delivery. The current setting can be checked and changed with the Dräger CC Vision software.

A version of the CC-Vision software that can be used for Dräger X-am 2500 is available for download from the product page for the X-am 2500 at the following web address: www.draeger.com

Changing the configuration: see “Replacing the sensors” on page 21.



WARNING

After a basic initialisation has been carried out with the PC software Dräger CC Vision, individual alarm settings may have been changed.

3.3.3 Configuring the device

To individually configure a standard-configuration device, connect the device to a PC. The installed PC software Dräger CC Vision is used for configuration.

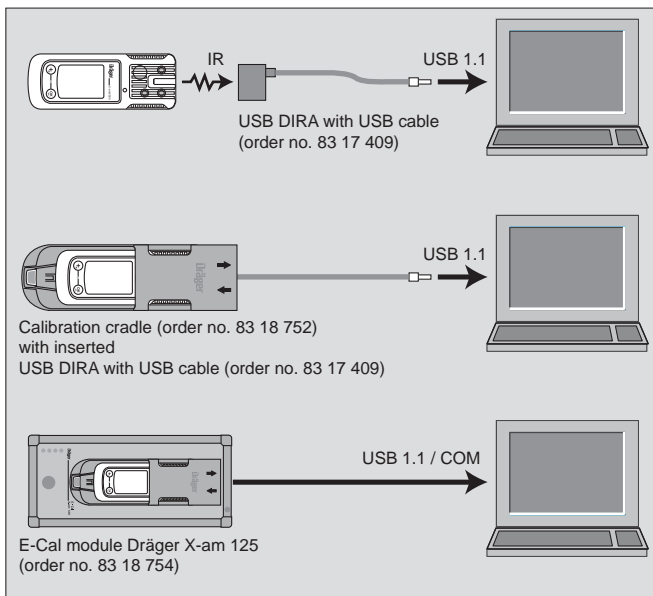

- Observe the documentation and online help of the software.
- A version of the CC-Vision software that can be used for Dräger X-am 2500 is available for download from the product page for the X-am 2500 at the following web address: www.draeger.com

3.3.4 Export data memory and display graphically

To read the database of the instrument and display it graphically, the instrument must be connected with a PC.

The installed Dräger GasVision PC software is used for exporting and displaying the database.

- Observe the documentation and online help of the software.

3.4 Running the bump test

3.4.1 Manual implementation without documentation of the results in the instrument memory

1. Prepare a test gas cylinder, the volume flow must be 0.5 l/min and the gas concentration must be higher than the alarm threshold concentration that is to be tested.
Example test gas cylinder 68 11 130 = mixed gas with 50 ppm CO, 15 ppm H₂S, 2.5 vol. % CH₄, 18 vol. % O₂
2. Connect the test gas cylinder with the calibration cradle (order no. 83 18 752).
3. Vent the test gas into a fume cupboard or into the open air (with a hose connected to the second connector of the calibration cradle).

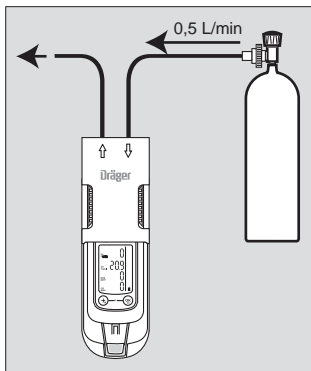

00833366.eps



CAUTION

Never inhale the test gas. Health hazard! Observe the hazard warnings of the relevant Safety Data Sheets.

4. Switch on the instrument and insert it into the calibration cradle – press downwards until it engages.
5. Open the test gas cylinder valve to let test gas flow over the sensors.
Recommendation: Wait until the instrument displays the test gas concentration with sufficient tolerance –
Ex: $\pm 20\%$ of the test gas concentration¹
O₂: ± 0.6 vol. %¹
TOX: $\pm 20\%$ of the test gas concentration¹
Wait until at least alarm threshold A1 or A2 has been exceeded, however.
If the alarm thresholds are exceeded, the instrument displays the gas concentration in alternation with » **A1** « or » **A2** « depending on the test gas concentration.
6. Close the test gas cylinder valve and remove the instrument from the calibration cradle.

If the concentration has now fallen under the A1 alarm threshold:

- Acknowledge the alarm.

If the displays are outside of the above-mentioned ranges:

- Calibrating/adjusting the instrument, see section 5 on page 17.

3.4.2 Menu implementation with the documentation of results in the instrument memory

The setting to "Quick bump test" or "Accelerated bump test" is made using the PC software Dräger CC Vision.

In the "Quick bump test" a check is carried out as to whether or not the gas concentration has exceeded alarm threshold 1 (with oxygen, the test checks that alarm threshold 1 has not been reached).

In the "Accelerated bump test" a check is carried out as to whether or not the gas concentration has exceeded alarm threshold 1 (with oxygen, the test checks that the alarm threshold has not been reached) and whether or not the gas concentration has reached the set bump test concentration.

Setting on delivery: Quick bump test.

1. Prepare a test gas cylinder, the volume flow must be 0.5 l/min and the gas concentration must be higher than the alarm threshold concentration that is to be tested.
Example test gas cylinder 68 11 130 = mixed gas with 50 ppm CO, 15 ppm H₂S, 2.5 vol. % CH₄, 18 vol. % O₂
2. Connect the test gas cylinder with the calibration cradle (order no. 83 18 752).
3. Vent the test gas into a fume cupboard or into the open air (with a hose connected to the second connector of the calibration cradle).

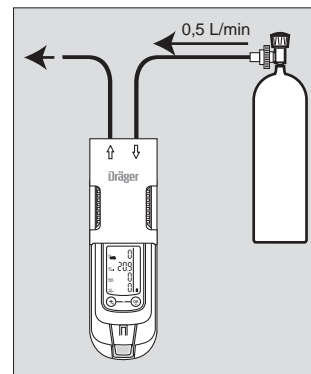

00833366.eps



CAUTION

Never inhale the test gas. Health hazard! Observe the hazard warnings of the relevant Safety Data Sheets.

4. Switch on the instrument and insert it into the calibration cradle – press downwards until it engages.
5. Open the Quick menu and select the bump test, page 16.
The current gas concentration values and the special symbol » **√0** « (for bump test) flash.
6. Press the **OK** key to start the bump test.
7. Open the test gas cylinder valve to let test gas flow over the sensor.
– If gas concentration exceeds the alarm thresholds A 1 or A 2 the corresponding alarm will occur.

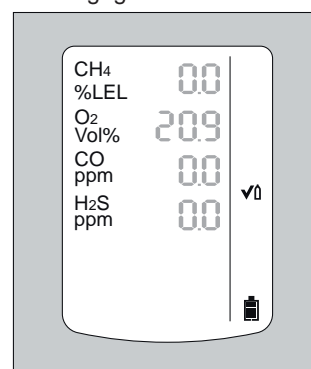

00833366_en.eps

¹ Upon application of the Dräger mixed gas (order no. 68 11 130) the displays should be within this range.

Ending the bump test:

After the set bump test concentration has been reached or a gas alarm has been triggered (with "Quick bump test"):

- The display containing the current gas concentration changes with the display » OK «.
 - The bump test that was carried out is documented with the result and date in the instrument memory.
8. Close the test gas cylinder valve and remove the instrument from the calibration cradle.
- If the concentration values have now fallen under the A1 alarm thresholds, the instrument returns to the measuring mode.
 - If the set bump test concentration is not reached within the set time, an error is issued.
 - The fault message »  « appears and » - - « is displayed instead of the measured value on the faulty measuring channel.
 - In this case, repeat the bump test or calibrate the instrument, page 21.

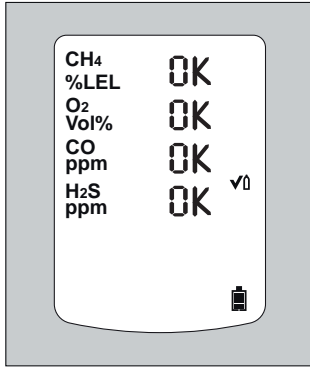

01133366_en.eps

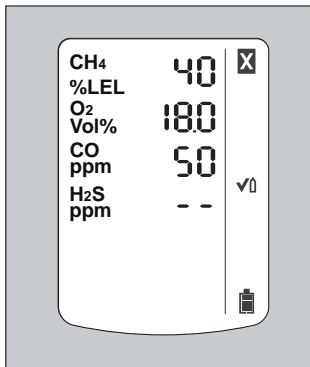

01133366_en.eps

The bump test can also be run automatically. The "Bump Test Station" is required for this function, see section 3.4.3 on page 14.

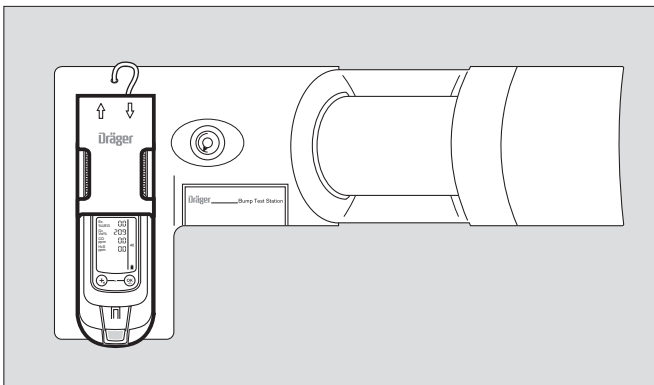
3.4.3 Automatic implementation with the Bump Test Station

01333366.eps

Prerequisite:

The instrument first needs to be configured for the automatic bump test using the Dräger CC-Vision PC software.

- Activating the instrument for the automatic bump test.
- Composition of test gas (mixed gas) – standard on delivery: 50 ppm CO, 15 ppm H₂S, 2.5 vol. % CH₄, 18 vol. % O₂

- Define which measuring channels should participate in the automatic bump test. All measuring channels participate in the bump test by default.

1. Prepare the Bump Test Station according to the instructions.
2. Switch on the instrument and insert it into the receptacle of the Bump Test Station until it engages. The bump test will be started automatically. The special symbol »  « (for bump test) flashes.

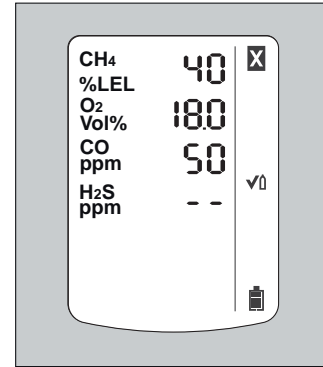

01133366_en.eps

If a gas alarm (quick bump test) is initiated and the set bump test concentration (Accelerated bump test) is reached within the set time, the current gas concentration will be displayed alternately with » OK «.

3. Remove the instrument from the Bump Test Station.
 - If the concentration values have now fallen under the A1 alarm thresholds, the instrument returns to the measuring mode.
 - If there is no alarm during the bump test and the current measurements do not reach the set target concentration ("Accelerated bump test" only), an error is issued.
 - The fault message »  « appears and » - - « is displayed instead of the measured value on the faulty measuring channel.
 - In this case, repeat the bump test or calibrate the instrument, page 21.

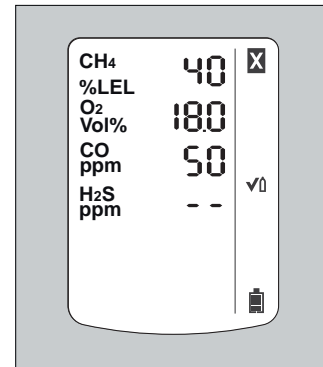



01133366_en.eps

The bump test can also be run manually, see section 3.4.1 on page 13.

The Dräger CC Vision PC software can be used to enable the "Automatic calibration after incorrect bump test" option.

3.5 During use

- During operation, the measured values for every measured gas are displayed.
- If a measuring range is exceeded or not reached, the following displays are shown instead of the measured value display:
 - »  « (measuring range exceeded) or
 - »  « (measuring range not reached).
- Excess concentrations of flammable materials can lead to a lack of oxygen.

- For O₂ concentrations under 8 vol. % an error is indicated with » - - « at the ex-channel instead of the measuring value as long as the measuring value falls below the pre-warning threshold (only if measuring range is ≤100 %LEL, not for >100 %LEL (heat conductance)).
- In the event of an alarm, the corresponding displays, including the visual, audible and vibration alarms, are activated, see section 6 on page 21.

If the measuring range is exceeded significantly at the CatEx channel (very high concentration of flammable materials), a blocking alarm is triggered. This CatEx blocking alarm is either acknowledged automatically through a functional oxygen channel (e. g. a channel free of warnings and defects) or manually by switching the instrument on and off in fresh air. No blocking alarm is triggered in the "methane" configuration setting when a measuring range is exceeded, because the unambiguousness of the display for methane is ensured via a separate measurement of the heat conductivity.



WARNING

After exposure to concentrations above 100 %LEL, incorrect displays may occur at the CatEx channel. Check the zero point and sensitivity and adjust it if necessary before continuing to use the instrument in a concentration range of 0 to 100 %LEL.

In the event of an impact load when using a CatEx sensor in the Dräger X-am 2500 that causes the fresh air display to deviate from zero, the zero point and sensitivity must be adjusted.

After the measuring range of the TOX measuring channels has been exceeded temporarily (up to one hour), checking the measuring channels is not necessary.

3.6 Identifying alarms

An alarm is displayed visually, audibly and through vibration in a specific pattern.

3.6.1 Concentration pre-alarm A1

Intermittent alarm: 

Display » **A1** « and measured value alternating:

The pre-alarm A1 is not latching and stops when the concentration has dropped below the alarm threshold A1.

- In case of A1, a single tone is audible and the alarm LED flashes.

Acknowledging the pre-alarm:

- Press the  key. Only the audible alarm and the vibration alarm are switched off.

3.6.2 Concentration main alarm A2



WARNING

Risk of fatal injury! Leave the area immediately. A main alarm is self-latching and cannot be acknowledged or cancelled.

Intermittent alarm: 

Display » **A2 and measured value** alternating:

- In case of A2, a double tone is audible and the alarm LED flashes twice.

After leaving the area, when the concentration has dropped below the alarm threshold:

- Press the  key. The alarm messages are switched off.



3.6.3 STEL / TWA exposure alarm



WARNING

Leave the area immediately. After this alarm, the deployment of personnel is subject to the relevant national regulations.

Intermittent alarm: 

Display » **A2** « and »  « (STEL) or »  « (TWA) and measured value alternating:

- The STEL and TWA alarm cannot be acknowledged or cancelled.
- Switch off the instrument. The values for the exposure evaluation are deleted after the instrument is switched on again.

3.6.4 Battery pre-alarm

Intermittent alarm: 

Flashing special symbol »  « on the right side of the display:

Acknowledging the pre-alarm:

- Press the  key. Only the audible alarm and the vibration alarm are switched off.
- The battery still lasts min. 20 minutes after the first battery pre-alarm.

3.6.5 Battery main alarm

Intermittent alarm: 

Flashing special symbol »  « on the right side of the display:

The battery main alarm cannot be acknowledged or cancelled:

- The device automatically switches off after 10 seconds.
- Before the instrument is switched off, the visual, audible and vibration alarms are activated for a short time.

3.6.6 Instrument alarm

Intermittent alarm: 

Special symbol »  « displayed on the right side of the display:

- The instrument is not ready for operation.
- For corrective measures, see "Replacing the sensors" on page 21 to page 24.
- Contact maintenance or Draeger Service to rectify the problem.

4 Menu functions

4.1 Activating the Info mode

- In measuring mode, press the **OK** key for approx. 3 seconds.
- If any warning or fault messages exist, the corresponding information or error codes will be displayed (see section 8 on page 22).
- Press the **OK** key successively for the next display.
- The peak values and the exposition values TWA¹ and STEL¹ are displayed.

I Warning messages are displayed. Numerical codes of warning messages: see section 8.1 on page 22.

OK key

X Fault messages are displayed. Numerical codes of fault messages: see section 8.2 on page 24.

OK key

▲ The peak values = the maximum measured values in the case of, e.g., CO, H₂S, ... or the minimum measured values in the case of O₂ within the storage interval are displayed

OK key

8 The average values of the exposures based on a shift of, e.g., 8 hours (TWA) of all the active sensors for the exposure evaluation are displayed

OK key

⌚ The short-term values (STEL) = average values of the concentrations over the average value duration of all the active sensors for the exposure evaluation are displayed

OK key

The instrument is in measuring mode again

- If no key is pressed for 10 seconds, the instrument returns automatically to measuring mode.

4.2 Opening Info-Off Mode

- When the instrument is in a deactivated state, press the **+** key.
The name of the gas, measuring unit, and measuring range limit value are displayed for all channels.
- Pressing the **OK** key again exits the Info Off mode (or via timeout).

4.3 Quick Menu

4.3.1 Quick menu functions

- √** Bump test see section 3.4 on page 13
- *** Fresh air calibration, see section 5.2 on page 17
- ▲** Display and clearing the peak values, see section 4.3.3 on page 16

4.3.2 Opening the Quick Menu

On delivery, only the fresh air calibration is activated in the Quick Menu. The PC software Dräger CC Vision can be used

¹ Only when activated in the instrument configuration. Delivery status: not activated.

to activate the bump test for the quick menu and/or the function for displaying and deleting peak values.

1. In measuring mode, press the **+** key three times.
If no functions have been activated in the quick menu, the instrument remains in measuring mode.
2. You can select the activated functions of the quick menu by pressing the **+** key.
 - Press the **OK** key to call the selected function.
 - Press the **+** key to cancel the active function and to switch to measuring mode.
 - If no key is pressed for 60 seconds, the instrument returns automatically to measuring mode.

4.3.3 Quick menu "Displaying and deleting peak values"

After the function has been selected, the current peak values are displayed; the peak values special symbol appears in the display at the same time.

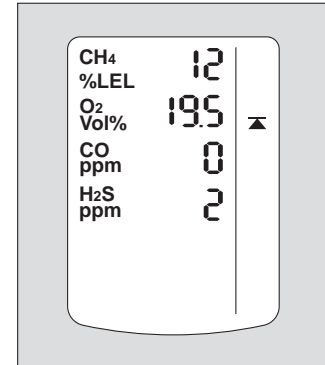

00433366_en.eps

1. The peak values can be deleted by pressing the **OK** key for 5 sec. and the adjacent display appears, for example.
2. Press the **OK** key to end the function.

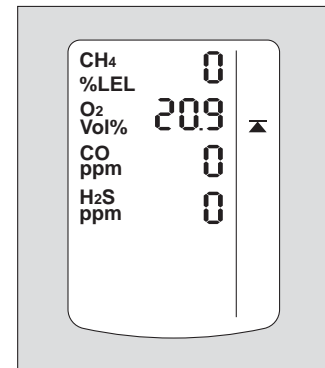

00533366_en.eps

4.4 Calibration Menu

4.4.1 Calibration menu functions

- *** Fresh air calibration, see section 5.2 on page 17
- 1** 1-button calibration, see section 5.3 on page 18
- U** Single gas calibration, see section 5.3.1 on page 19

4.4.2 Open the Calibration Menu

- The calibration menu can only be accessed by entering a password.
Password on delivery: » **001** «
- The default password on delivery can be changed using the PC software Dräger CCVision.

- In measuring mode, press the \oplus key for at least 4 seconds. The function for entering the password is selected. The special symbol » \mathbb{A} « (for the "enter password" function) is displayed.

The display shows » 000 «, with the first digit flashing.

- Use the \oplus key to set the flashing digit.
- Press the OK key, the second digit starts flashing.
- Use the \oplus key to set the flashing digit.
- Press the OK key, the third digit starts flashing.
- Use the \oplus key to set the flashing digit.
- Press the OK key to confirm the password once it has been set completely.
- The calibration menu functions can now be selected by pressing the \oplus key.
 - Press the OK key to call the selected function.
 - Press the \oplus key to cancel the active function.
 - If no key is pressed for 10 minutes, the instrument automatically returns to measuring mode.

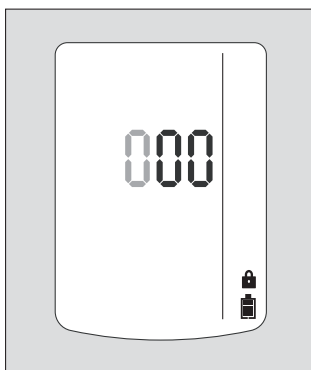

00633366.eps

5 Calibrate instrument



WARNING

Always calibrate the zero-point before span. Otherwise, the calibration will contain errors!

- Adjustment may not be possible due to instrument and channel errors.
- Allow the sensors to warm up before the calibration!
- Warming-up time: see instructions for use / data sheets for the Dräger sensors installed (product page for X-am 2500 at www.draeger.com).

5.1 Adjustment interval:

- Observe the relevant specifications in the Instructions for Use/data sheets of the Dräger Sensors installed.
- For critical applications, observe the recommendations in EN 60079-29-2¹ or EN 45544-4² and national regulations. We recommend that you adjust all the channels after 6 months.



CAUTION

Never inhale the test gas. Health hazard! Observe the hazard warnings of the relevant Safety Data Sheets.

- EN60079-29-2 – Guidelines for selection, installation, use and maintenance of instruments for the detection and measurement of flammable gases and oxygen.
- EN 45544-4 – Electrical instruments for the direct detection and direct concentration measurement of toxic gases and vapours – Part 4: Guide for selection, installation, use and maintenance.

- Improving the zero point accuracy – perform fresh air calibration, page 17.
- Set the sensitivity of all sensors to the value of the test gas – carry out the 1-button calibration, page 18.
- Set the sensitivity of a sensor to the value of the test gas – span calibration/adjustment, page 19.

5.2 Run fresh air calibration

To improve the zero-point accuracy, a fresh air calibration can be carried out.

- Calibrate the instrument to fresh air, free of measured gases or other interfering gases.
- Sensors which have not warmed up or which are faulty prevent a calibration.
 - In the case of sensors which are in the warm-up phase, the message » 159 « is displayed with the special symbol » \mathbb{A} « (for warning message).
 - In the case of a sensor or instrument error, the message » 109 « is displayed with the special symbol » \mathbb{A} « (for a fault message).
 - The message is cleared after 5 seconds and the function is available again in the menu.
- During the fresh air calibration the zero point of all sensors (with the exception of the DrägerSensor XXS O₂) are set to 0.
- In the case of the DrägerSensor XXS O₂, the display is set to 20.9 vol. %.

- Switch on instrument.
- Depending on instrument configuration:
 - Open the Quick menu and select the fresh air calibration function, page 16.
 - or
 - Open the Calibration menu and select the fresh air calibration function, page 16.
- The current gas concentration values flash.
- When the measured values have stabilized:
- Press the OK key to carry out the fresh air calibration.

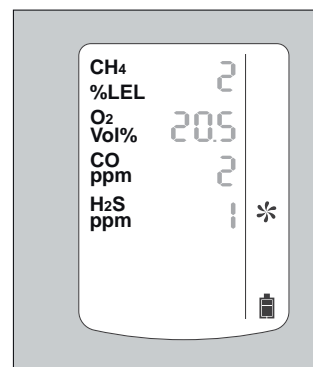

01333366_en.eps

- The display containing the current gas concentration changes with the display » OK «.
- Press the OK key to confirm the calibration or wait for approx. 5 seconds.

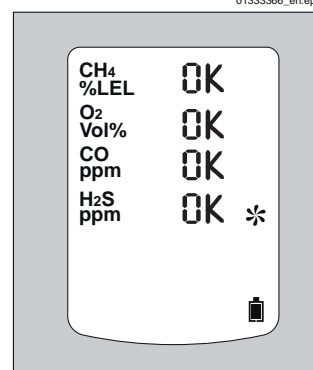

01433366_en.eps

If a fault has occurred during the fresh air calibration:

- The fault message »  « appears and » - - « is displayed for the respective sensor instead of the measured value.
- In this case, repeat the fresh air calibration.
- Replace the sensor if necessary, page 21.

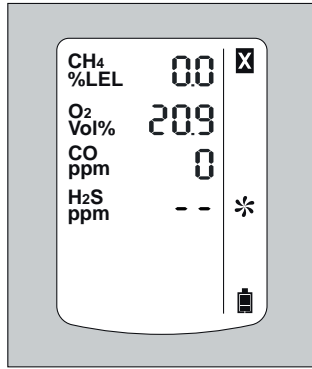

01533366_en.eps

5.3 1-button calibration

NOTICE

If no sensors have been approved by the Dräger CC-Vision PC program for the 1 button calibration, the 1-button calibration will not be available.

- All sensors approved by the Dräger CC-Vision PC program are included in the 1-button calibration.
- In the case of the 1-button calibration, the sensitivity of all sensors is set to the value of the test gas. When using test gas cylinder 68 11 130 = mixed gas with 50 ppm CO, 15 ppm H₂S, 2.5 vol. % CH₄, 18 vol. % O₂.

- If a mixed gas with another composition is used, the specified concentration values in the instrument must be changed to the target values of the mixed gas used using the PC software "Dräger CC-Vision".

1. Connect the test gas cylinder with the calibration cradle.
2. Vent the test gas into a fume cupboard or into the open air (with a hose connected to the second connector of the calibration cradle).

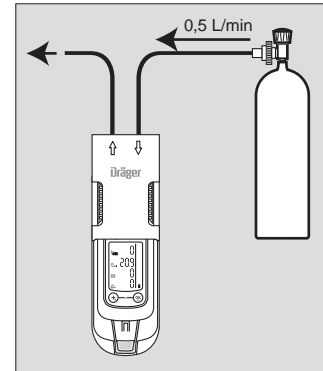

00833366.eps



CAUTION

Never inhale the test gas. Health hazard! Observe the hazard warnings of the relevant Safety Data Sheets.



3. Switch on the instrument and insert it into the calibration cradle until it engages.
4. Call the calibration menu, enter the password and select the 1-button calibration function, page 16.
5. Press the  key to start the 1-button calibration.
6. Open the test gas cylinder valve to let test gas flow over the sensor.

The currently displayed measured values start to flash.

The flashing stops after a static measured value has been reached.

The calibration is now carried out automatically.

The displayed measured values change to the values according to the gas supplied.

7. The automatic stability monitoring can be overridden by pressing the  key. A calibration is carried out immediately. If it is detected that no test gas has been supplied, the 1-button calibration is cancelled. The channels then display » **n/a** «. If only one sensor is included in the 1-button calibration, an adjustment is carried out in any case when the  key is pressed.

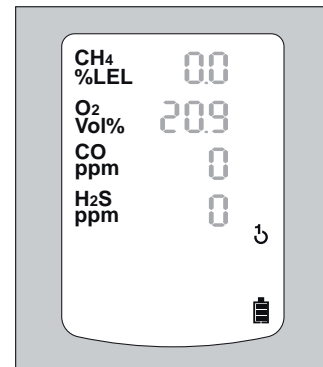

01633366_en.eps

When the calibration is completed and the displayed measured values have stabilised:

- The display containing the current gas concentration changes with the display » OK «.
- 8. Press the **OK** key or wait for 5 seconds to quit the calibration.
- The instrument changes to the measuring mode
- 9. Close the test gas cylinder valve and remove the instrument from the calibration cradle.

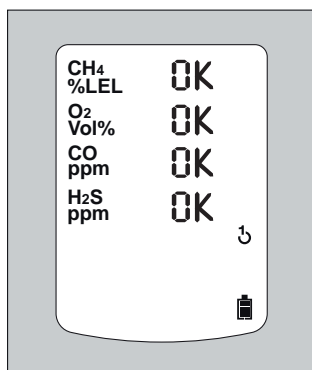

If a fault occurs during the 1-button calibration:

- The fault message » **✖** « appears and » - - « is displayed for the respective sensor instead of the measured value.
- In this case, repeat the 1-button calibration or carry out a single gas calibration, see section 5.3.1 on page 19.
- Replace the sensor if necessary, page 21.

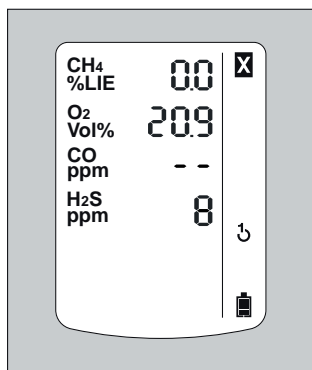

5.3.1 Calibrating the sensitivity for an individual measuring channel

- The span calibration can be carried out specifically for individual sensors.
- In the case of the span calibration, the sensitivity of the selected sensor is set to the value of the test gas used.
- Use a standard test gas. Allowed test gas concentration:
 Ex: 40 to 100 %LEL
 O₂ 10 to 25 vol. %
 CO: 20 to 999 ppm
 H₂S: 5 to 99 ppm
 Test gas concentration of other gases: see Instructions for Use for the respective DrägerSensors.

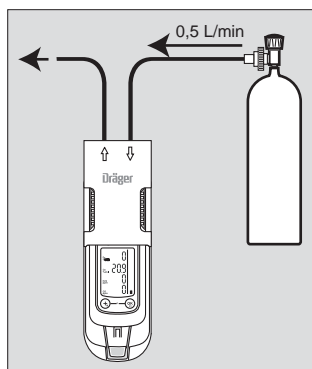

1. Connect the test gas cylinder with the calibration cradle.
2. Vent the test gas into a fume cupboard or into the open air (with a hose connected to the second connector of the calibration cradle).



CAUTION

Never inhale the test gas. Health hazard! Observe the hazard warnings of the relevant Safety Data Sheets.

3. Switch on the instrument and insert it into the calibration cradle.
4. Press the **[+]** key and keep it pressed for 5 seconds to open the calibration menu, enter the password and select the single gas calibration function, page 16.
5. Press the **OK** key to start the channel selection.

- The display flashes the gas of the first measuring channel, e.g. » Ex %LEL «.
- 6. Press the **OK** key to start the calibration function of this measuring channel, or use the **+** key to select another measuring channel (O₂ - vol. %, H₂S - ppm or CO - ppm).

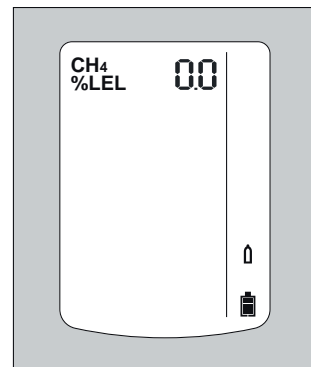

5.3.2 Sensitivity calibration for CatEx

If the measuring range end value $< = 100$ LEL, the calibration for catalytic effect is suggested.

Display on channel selection:

1. Press the **OK** key to start the catalytic effect calibration.

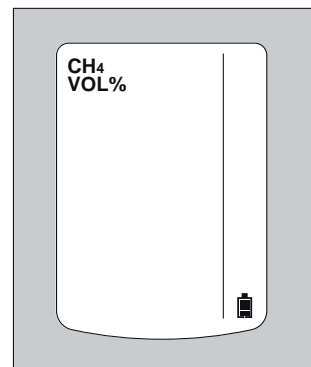

2. Press the **+** key to select the next sensor.

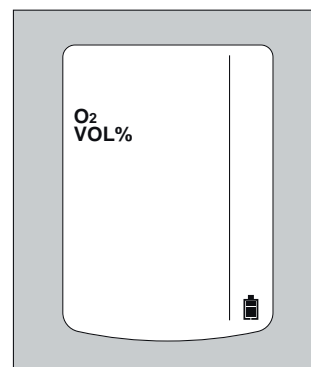

If the measuring range end value >100 LEL, the calibration for catalytic effect and heat conduction is suggested, display on channelselection:

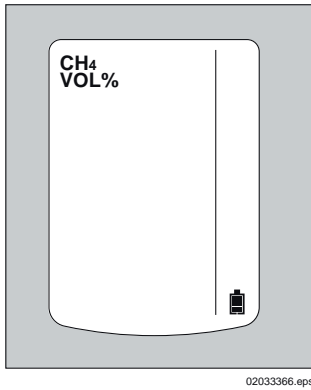

3. After pressing the **OK** key, the following appears on the display:

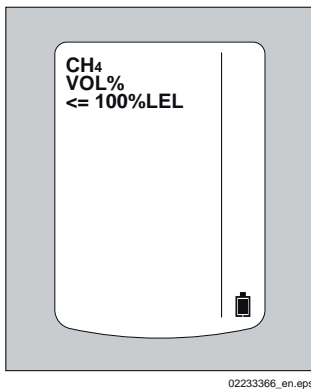

4. Press the **OK** key to start the catalytic effect calibration.

5. After pressing the **+** key, the following appears on the display:

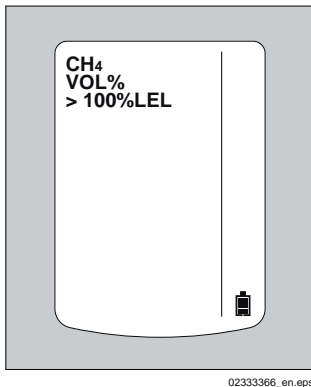

6. Press the **OK** key to start the heat conduction calibration.

7. **+** key can be pressed to select the next sensor.

8. Press the **OK** key to carry out the calibration of the selected measuring channel. The calibration gas concentration is displayed

9. Press the **OK** key to confirm the calibration gas concentration or use the **[+]** key to change the calibration gas concentration and complete the process by pressing the **OK** key. The measurement value flashes.

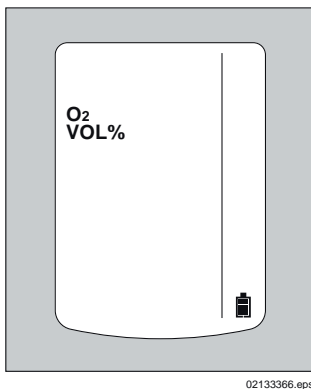

10. Open the test gas cylinder valve to let test gas flow over the sensor.

The displayed, flashing measurement value changes to the value according to the supplied test gas.

When the displayed measurement value has stabilised:

11. Press the **OK** key to carry out the calibration.

The display containing the current gas concentration changes with the display **» OK «**.

12. Press the **OK** key or wait for approx. 5 seconds to quit the calibration of this measuring channel.

The next measuring channel appears for calibration.

After the calibration of the last measuring channel, the instrument changes to the measuring mode.

13. Close the test gas cylinder valve and remove the instrument from the calibration cradle.



If a fault has occurred during the sensitivity calibration:

- The fault message **» ✖ «** appears and **» - - «** is displayed for the respective sensor instead of the measured value.
- In this case, repeat the calibration.
- Replace the sensor if necessary, page 21.

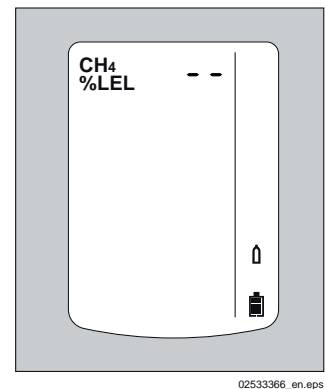

Notice for the adjustment of the ex-channel to nonane as a measuring gas:

- During the calibration of the ex-channel, propane can be used as a substitute calibration gas.
- When using propane to adjust the ex-channel to nonane, the display must be set to twice the used test gas concentration.

Notice for the use in subsurface mining:

- For the calibration of the ex-channel to the measuring gas methane, the display of the instrument must be set to a value of 5 % (relative) higher than the used test gas concentration.

6 Operation with pump

With Dräger Pump X-am 1/2/5000

Accessories:

Dräger Pump X-am 1/2/5000, sampling hose and probes, see section 12 on page 31.

Commissioning and performing the measurement:

- Refer to the Instructions for Use of the Dräger Pump X-am 1/2/5000.

With manual pump adapter and rubber ball pump

Accessories:

For manual pump adapter, rubber ball pump, sampling hose and probes, see section 12 on page 31.

Commissioning and performing the measurement:

- Refer to the Instructions for Use of the accessories used.

Observe the following during measuring mode with pump

- Wait for the flushing time to elapse:
Before every measurement, flush the Dräger sampling hose or the Dräger probes with the air sample to be measured.
- A flushing phase is necessary to eliminate or minimise all effects associated with the use of a sampling hose or a probe, e.g. memory effects, dead volume.
- The duration of the flushing phase depends on factors such as type and concentration of the gas or vapour to be measured, material, length, diameter, and age of the sampling hose or probe. Generally, when using a sampling hose (new, dry, clean), a typical flushing time of approx. 3 seconds is required for each metre. This flushing time applies in addition to the sensor response time (see the Instructions for Use for the gas detection instrument used).
Example:
In the case of a sampling hose with a length of 10 m, the flushing time is approx. 30 seconds and the sensor response time is in addition approx. 60 seconds. Therefore, the total time before reading the gas measuring instrument is approx. 90 seconds.
The flow-rate alarm is delayed by 10 to 30 seconds depending on the length of the hose.

7 Replacing the sensors

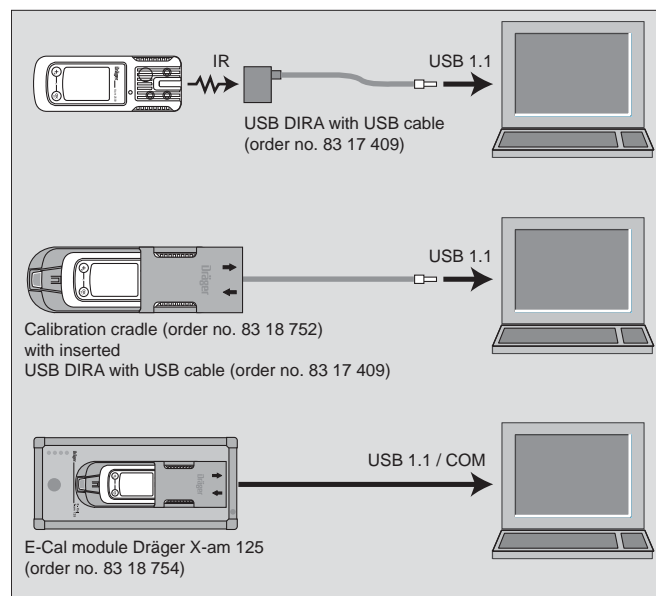

00733366_en.eps

- To replace the sensors of the instrument, connect the instrument with a PC.
- Replace the sensors using the PC program Dräger CC Vision.

Next:

- Conduct the fresh air calibration page 17.
- and then:

- Calibrating sensitivity:
either
perform 1-button calibration, page 18
or
run sensitivity calibration, see page 19.

8 Troubleshooting

Fault	Cause	Remedy
Not possible to switch on the instrument	Discharged power pack	Charge the power pack, page 8.
	Discharged alkaline batteries	Insert new alkaline batteries, page 21.
Not possible to switch off the instrument	The instrument is not set to measuring mode	Select measuring mode.
	The instrument is configured to "Disable prohibited"	Configure the instrument to "Disable allowed" with Dräger CC Vision.
Display » -- «	Measuring range calibrated/adjusted incorrectly	Recalibrate/adjust the measuring range, page 21.
	Electronics or sensors defective	Must be repaired by Service.

List of the numerical codes of the warning and fault messages in the info mode, see page 16.

8.1 Warning messages

Special symbol » ⓘ « and displayed numerical code:	Cause	Remedy
152	Customer's service life counter about to elapse	Reset the service life counter using Dräger CC Vision.
153	Database 90 % full	Read the database soon and clear memory afterwards.
154	Database full	Read the database and clear memory.
155	Interval for bump test elapsed	Conduct the bump test page 21.
159	Calibration not possible. The menu function cannot be carried out because of a message which is preventing the function (e.g. sensors in warm-up phase).	Determine the message code via the info menu and switch it off, if necessary.
251	DrägerSensor CatEx 125 PR warming up	Wait until warm-up time is complete.
252	DrägerSensor CatEx 125 PR warming up	Wait until warm-up time is complete.
253	Ex concentration has drifted into the negative range	Conduct the fresh air calibration page 17.
254	The temperature is too high	Operate the instrument within the allowed temperature range.
255	The temperature is too low	Operate the instrument within the allowed temperature range.
256	Calibration interval for DrägerSensor CatEx 125 PR has expired	Perform sensitivity calibration for DrägerSensor CatEx 125 PR, page 19.
257	Alarm threshold A2 is set to greater than 60 %LEL	Set alarm threshold to less than 60 %LEL.
271	Heat conductance calibration interval for DrägerSensor CatEx 125 PR has expired	Perform sensitivity calibration for DrägerSensor CatEx 125 PR, page 19.
351	DrägerSensor XXS EC1 is warming up	Wait until warm-up time is complete.
352	DrägerSensor XXS EC1 is warming up	Wait until warm-up time is complete.
353	EC1 concentration has drifted into the negative range	Conduct the fresh air calibration page 17.
354	The temperature is too high	Operate the instrument within the allowed temperature range.
355	The temperature is too low	Operate the instrument within the allowed temperature range.

Special symbol » ⓘ « and displayed numerical code:	Cause	Remedy
356	The calibration interval for DrägerSensor XXS EC1 has elapsed	Run sensitivity calibration for DrägerSensor XXS EC1, page 19.
357	Alarm threshold A2 is set to greater than 60 %LEL	Set alarm threshold to less than 60 %LEL.
451	DrägerSensor XXS EC2 in the warm-up phase	Wait until warm-up time is complete.
452	DrägerSensor XXS EC2 in the warm-up phase	Wait until warm-up time is complete.
453	EC2 concentration has drifted into the negative range	Conduct the fresh air calibration page 17.
454	The temperature is too high	Operate the instrument within the allowed temperature range.
455	The temperature is too low	Operate the instrument within the allowed temperature range.
456	The calibration interval for DrägerSensor XXS EC2 has elapsed	Run sensitivity calibration for DrägerSensor XXS EC 3, page 19.
457	Alarm threshold A2 is set to greater than 60 %LEL	Set alarm threshold to less than 60 %LEL.
551	DrägerSensor XXS EC3 in the warm-up phase	Wait until warm-up time is complete.
552	DrägerSensor XXS EC3 in the warm-up phase	Wait until warm-up time is complete.
553	EC3 concentration has drifted into the negative range	Conduct the fresh air calibration page 17.
554	The temperature is too high	Operate the instrument within the allowed temperature range.
555	The temperature is too low	Operate the instrument within the allowed temperature range.
556	The calibration interval for DrägerSensor XXS EC3 has elapsed	Run sensitivity calibration for DrägerSensor XXS EC 3, page 19.
557	Alarm threshold A2 is set to greater than 60 %LEL	Set alarm threshold to less than 60 %LEL.
575	The calibration interval for the compensation electrode has elapsed	Run sensitivity calibration for the compensation electrode.
576	Calibration requested due to overgassing	Run sensitivity calibration for the compensation electrode.
651	DrägerSensor XXS EC 4 in the warm-up phase	Wait until warm-up time is complete.
652	DrägerSensor XXS EC 4 in the warm-up phase	Wait until warm-up time is complete.
653	EC 4 concentration has drifted into the negative range	Conduct the fresh air calibration page 17.
654	The temperature is too high	Operate the instrument within the allowed temperature range.
655	The temperature is too low	Operate the instrument within the allowed temperature range.
656	The calibration interval for DrägerSensor XXS EC 4 has elapsed	Run sensitivity calibration for DrägerSensor XXS EC 4, page 19.
657	Alarm threshold A2 is set to greater than 60 %LEL	Set alarm threshold to less than 60 %LEL.

8.2 Fault messages

Special symbol » ☒ « and displayed numerical code:	Cause	Remedy
102	The customer's service life counter has elapsed	Reset the service life counter using Dräger CC Vision.
103	The instrument is defective	The instrument must be repaired by Service.
104	Check sum error program code	The instrument must be repaired by Service.
105	Bump test interval elapsed	Run the bump test page 14.
106	The calibration interval has elapsed (at least 1 calibration interval has elapsed)	Run sensitivity calibration, see page 18 and/or page 19.
107	Bump test error (at least 1 channel has a bump test error)	Run bump test, page 14 or run sensitivity calibration, page 18 and/or page 19.
108	The instrument is defective	The instrument must be repaired by Service.
109	The menu function cannot be carried out because of an error	Determine the error code via the info menu and switch it off, if necessary.
111	Faulty alarm element test: Alarm light	Repeat alarm element test using X-dock.
112	Faulty alarm element test: Alarm horn	Repeat alarm element test using X-dock.
113	Faulty alarm element test: Vibration motor	Repeat alarm element test using X-dock.
114	Faulty visual inspection	Repeat visual inspection using X-dock.
115	Instrument deactivated by X-dock	Instrument activated using X-dock.
116	Faulty software update	The instrument must be repaired by Service.

201	No valid zero point calibration of the DrägerSensor CatEx 125 PR	Conduct the fresh air calibration page 17.
202	No valid sensitivity calibration of the DrägerSensor CatEx 125 PR	Run sensitivity calibration, see page 18 and/or page 19.
203	Measurement from DrägerSensor CatEx 125 PR is in negative range	Conduct the fresh air calibration page 17.
204	DrägerSensor CatEx 125 PR not plugged in or faulty	Check DrägerSensor CatEx 125 PR, page 21
205	Error during bump test of DrägerSensor CatEx 125 PR	Repeat bump test, where necessary, calibrate or replace the DrägerSensor CatEx 125 PR, page 21.
207	Faulty rise time test	Repeat rise time test using X-dock.
221	Too little oxygen to operate the DrägerSensor CatEx 125 PR	Operate sensor in an environment with at least 10 vol. % O ₂ .
222	No valid zero point calibration of the DrägerSensor CatEx 125 PR for heat conduction	Conduct the fresh air calibration page 17.
223	No valid sensitivity calibration of the DrägerSensor CatEx 125 PR for heat conduction	Run heat conduction sensitivity calibration, see page 18 and/or page 19.

301	No valid zero point calibration of the Dräger Sensor XXS EC1	Conduct the fresh air calibration page 17.
302	No valid sensitivity calibration of the Dräger Sensor XXS EC1	Run sensitivity calibration, see page 19 and/or fresh air calibration, page 17.
303	The measured value of DrägerSensor XXS EC 1 is in the negative range	Conduct the fresh air calibration page 17.
304	DrägerSensor XXS EC1 is not inserted or faulty	Check Dräger Sensor XXS EC1, page 21.

Special symbol » ☒ « and displayed numerical code:	Cause	Remedy
305	Error in bump test of Dräger Sensor XXS EC1	Repeat bump test, calibrate or replace DrägerSensor XXS EC1, if necessary page 21.
306	Faulty filter test	Repeat filter test using X-dock.
307	Faulty rise time test	Repeat rise time test using X-dock.
326	Error during warm-up acceleration Dräger Sensor XXS EC1	Disconnect and reconnect power pack or replace the sensor. Sensor must not be loaded with gas within the first 5 minutes.

401	No valid zero point calibration of the Dräger Sensor XXS EC2	Conduct the fresh air calibration page 17.
402	No valid sensitivity calibration of the Dräger Sensor XXS EC2	Run sensitivity calibration, page 19.
403	The measured value of DrägerSensor XXS EC2 is in the negative range	Conduct the fresh air calibration page 17.
404	DrägerSensor XXS EC2 is not inserted or faulty	Check Dräger Sensor XXS EC2, page 21.
405	Error in bump test of Dräger Sensor XXS EC2	Repeat function test, calibrate or replace Dräger Sensor XXS EC2, if necessary page 21.
406	Faulty filter test	Repeat filter test using X-dock.
407	Faulty rise time test	Repeat rise time test using X-dock.
426	Error during warm-up acceleration Dräger Sensor XXS EC2	Disconnect and reconnect power pack or replace the sensor. Sensor must not be loaded with gas within the first 5 minutes.

501	No valid zero point calibration of the Dräger Sensor XXS EC3	Conduct the fresh air calibration page 17.
502	No valid sensitivity calibration of the Dräger Sensor XXS EC3	Run sensitivity calibration, page 19.
503	The measured value of DrägerSensor XXS EC3 is in the negative range	Conduct the fresh air calibration page 17.
504	DrägerSensor XXS EC3 is not inserted or faulty	Check Dräger Sensor XXS EC3, page 21.
505	Error in bump test of Dräger Sensor XXS EC3	Repeat bump test, calibrate or replace DrägerSensor XXS EC3, if necessary page 21.
506	Faulty filter test	Repeat filter test using X-dock.
507	Faulty rise time test	Repeat rise time test using X-dock.
525	No valid sensitivity calibration for the compensation channel	Run sensitivity calibration for the compensation electrode.
526	Error during warm-up acceleration Dräger Sensor XXS EC3	Disconnect and reconnect power pack or replace the sensor. Sensor must not be loaded with gas within the first 5 minutes.

601	No valid zero point calibration of the Dräger Sensor XXS EC4	Conduct the fresh air calibration page 17.
602	No valid sensitivity calibration of the Dräger Sensor XXS EC4	Run sensitivity calibration, page 19.
603	The measured value of Dräger Sensor XXS EC4 is in the negative range	Conduct the fresh air calibration page 17.
604	DrägerSensor XXS EC4 is not inserted or faulty	Check Dräger Sensor XXS EC4, page 21.
605	Error in bump test of Dräger Sensor XXS EC4	Repeat bump test, calibrate or replace DrägerSensor XXS EC4, if necessary page 21.

Special symbol » ☒ « and displayed numerical code:	Cause	Remedy
606	Faulty filter test	Repeat filter test using X-dock.
607	Faulty rise time test	Repeat rise time test using X-dock.
626	Error during warm-up acceleration Dräger Sensor XXS EC4	Disconnect and reconnect power pack or replace the sensor. Sensor must not be loaded with gas within the first 5 minutes.

9 Maintenance

9.1 Maintenance table

The instrument should be inspected and maintained by suitably qualified persons annually (consult: EN 60079-29-2 – Guide for the selection, installation, use and maintenance of apparatus for the detection and measurement of combustible gases or oxygen, EN 45544-4 – Electrical apparatus used for the direct detection and direct concentration measurement of toxic gases and vapours - Part 4: Guide for selection, installation, use and maintenance and national regulations).

Recommended calibration interval for measuring channels Ex, O₂, H₂S and CO: 6 months.



NOTICE

Calibration intervals of other gases: see Instructions for Use of the respective DrägerSensors.

- Depending on instrument configuration:
 - Replace the alkaline batteries or charge the battery – see section 3.1.2 on page 9 – after each use, at the latest after the battery alarm has been triggered or after 2 weeks.
- Calibrating the instrument – see section 5 on page 17.
 - At regular intervals, according to the sensors used and the operating conditions. For sensor-specific calibration data, refer to the Instructions for Use/data sheets of the sensors used¹.
 - Before you carry out safety-related relevant measurements, the zero point and sensitivity of the instruments should be tested in accordance with national regulations.
- Inspection by suitably qualified persons – every year.
 - The inspection intervals must be established in each individual case and shortened if necessary, depending on technical safety considerations, engineering conditions, and the technical requirements of the equipment.
 - We recommend that a service agreement be concluded with Dräger and that repairs also be carried out by them.
- Replace the sensors, page 21 – if necessary, when it is not possible to calibrate the sensors any more.

9.2 Cleaning



CAUTION

Abrasive cleaning implements (brushes etc.), cleaning agents and cleaning solvents can destroy the dust and water filters.

- The instrument does not need any special care.
- Dirt and deposits can be removed from the instrument by washing it with cold water. A sponge can be used for wiping if necessary.
- Carefully dry the instrument with a cloth.

¹ Instructions for use/data sheets for the Dräger sensors can be downloaded from the product page for the X-am 2500 on the following website: www.draeger.com. See also the enclosed instructions for use and data sheets for the sensors used.

10 Disposal

Dispose of product in accordance to applicable regulations.

10.1 WEEE



In accordance with EU Directive 2002/96/EC this product must not be disposed of as household waste. This is indicated by with the adjacent icon.

You can return this product to Dräger free of charge. For information please contact the national marketing organisations and Dräger.

10.2 Battery disposal



In accordance with EU Directive 2006/66/EC, batteries and rechargeable batteries must not be disposed of as household waste but must be taken to battery collection centres. This is indicated by the adjacent icon. Collect batteries and rechargeable batteries as specified by the applicable regulations and dispose of at battery collection centres.

10.3 Electrochemical sensors



WARNING

Acid burn risk!
Do not throw into fire or open with force.



As with batteries, dispose of as special waste in line with local waste disposal regulations. Further information can be obtained from the relevant local authority and from appropriate waste disposal companies.

The DrägerSensor CatEx 125 PR should be disposed of as electronics waste.

11 Technical data

11.1 X-am 2500

Ambient conditions:	
during operation and storage	–20 to +50 °C for NiMH power pack type: HBT 0000 and HBT 0100, and for alkaline single cell type: Duracell Procell MN 1500 ¹ –20 to +40 °C for NiMH single cell type: GP 180AAHC ¹ and for alkaline single cell type: Panasonic LR6 Powerline 0 to +40 °C for alkaline single cell type: Varta 4006 ¹ , Varta 4106 ¹ 700 to 1300 hPa 10 to 90 % (short-term up to 95 %) relative humidity
Instrument data	
Protection class	IP 67 for instruments with sensors
Alarm volume	Typically 90 dB (A) at 30 cm distance
Operating time:	
Alkaline battery	Typically 12 hours under normal conditions
NiMH power pack:	
T4 (type HBT 0000)	Typically 12 hours under normal conditions
T4 HC (type HBT 0100)	Typically 13 hours under normal conditions
Dimensions	approx. 130 mm x 48 mm x 44 mm (H x W x D)
Weight	approx. 220 g to 250 g
CE mark	Electromagnetic compatibility (Directive 2004/108/EC) Explosion protection (Directive 94/9/EC)
Approvals:	see section 2.3 on page 6

1) Not subject to BVS10 ATEX E 080X and PFG 10 G 001X performance approval.

11.2 Sensor Data

Extract! For details, see the data sheets for the sensors used (Instructions for use/data sheets for the Dräger sensors can be downloaded from the product page for the X-am 2500 on the following website: www.draeger.com)

	Ex	XXS O ₂	XXS H ₂ S-LC	XXS CO
Measuring principle	Catalytic oxidation	Electrochemical	Electrochemical	Electrochemical
Measurement value configuration time t _{0..0.90} for methane for propane	≤17 seconds ≤25 seconds	≤10 seconds	≤18 seconds	≤25 seconds
Measurement value configuration time t _{0...50} for methane for nonane	≤7 seconds ≤40 seconds ¹	≤6 seconds	≤6 seconds	≤6 seconds
Measuring range for methane	0 to 100 %LEL ² 0 to 5 vol. %	0 to 25 vol. %	0 to 100 ppm H ₂ S ³	0 to 2000 ppm CO ⁴
Zero error (EN 45544)	---	---	0.4 ppm	6 ppm
Instrument drift	---	---	≤1 % of measured value/month	≤1 % of measured value/month
Warm-up time	35 seconds	≤5 minutes	≤5 minutes	≤5 minutes
Effect of sensor poisons Hydrogen sulphide H ₂ S, 10 ppm Halogenated hydrocarbons, heavy metals, substances containing silicone, sulphur or polymerisable substances	≤1 %LEL/ 8 hours Poisoning possible	---	---	---
Linearity error	≤5 %LEL	≤0.3 vol. %	≤2 % of the measured value	≤3 % of the measured value
Standards (Measuring function for explosion protection and measurement of oxygen deficiency and surplus as well as toxic gases, DEKRA EXAM GmbH, Essen, Germany: BVS 10 ATEX E 080X ²⁾ , PFG 10 G 001X	EN 60079-29-1 ⁵ EN 50271	EN 50104 ⁶ (measurement of oxygen deficiency and oxygen surplus) EN 50271	EN 45544-1/-2 ⁷ EN 50271	EN 45544-1/-2 ⁸ EN 50271
Cross sensitivities ⁹	Fitted	Fitted	Fitted	Fitted

	XXS NO ₂	XXS SO ₂
Measuring principle	Electrochemical	Electrochemical
Measurement value configuration time t _{0..0.90}	≤15 seconds	≤15 seconds
Measurement value configuration time t _{0...50}	---	---
Measuring range for methane	0 to 50 ppm NO ₂	0 to 100 ppm SO ₂
Zero error	0.2 ppm	0.1 ppm
Instrument drift	≤2 % the measuring value/month	≤2 % the measuring value/month
Warm-up time	≤5 minutes	≤5 minutes
Effect of sensor poisons Hydrogen sulphide H ₂ S, 10 ppm halogenated hydrocarbons, heavy metals, gases containing silicone, sulphur or polymerizable substances	---	---
Linearity error	≤±2 % of the measured value	≤±2 % of the measured value
Standards (Measuring function for explosion protection and measurement of oxygen deficiency and surplus as well as toxic gases, DEKRA EXAM, Essen, Germany: BVS 10 ATEX E 080X ²⁾ , PFG 10 G 001X	---	---
Cross sensitivities ⁸⁾	Fitted	Fitted

- 1) For decreasing concentrations, the adjustment time for nonane is about 50 seconds.
- 2) For alkanes from methane to nonane, LEL-values in accordance with EN 60079-20-1. For flow speeds of 0 to 6 m/s the deviation of the display can be 5 - 10 % of the measuring value. For an adjustment to propane, the deviation of the display in the range of 80 to 120 kPa can be up to 6 %LEL.
- 3) Certified for 0.4 to 100 ppm
- 4) Certified for 3 to 500 ppm
- 5) The instrument responds to most combustible gases and vapours. The sensitivities differ depending on the type of gas. We recommend a calibration using the target gas to be measured. For the range of alkanes, the sensitivity decreases from methane to nonane.
- 6) The measuring signals may be negatively affected by ethane, ethene, ethyne, carbon dioxide and hydrogen.
- 7) The measuring signals may be additively affected by sulphur dioxide, nitrogen dioxide and hydrogen, and negatively affected by chlorine.
- 8) The measuring signals can be affected additively by acetylene, hydrogen and nitrogen monoxide.
- 9) A table of the cross sensitivities is contained in the Instructions for Use or the data sheet of the respective sensor.

12 Order list

Name and description	Order no.
Dräger X-am 2500 Unlimited 1 to 4 multi gas monitors with exchangeable sensors. With selectable special calibration. Standard calibration for the ex-sensor: methane. Including country-specific adjustable standard alarm thresholds.	
Dräger X-am 2500 standard instrument: Dräger X-am 2500 Ex 83 23 910 Dräger X-am 2500 Ex, O ₂ 83 23 912 Dräger X-am 2500 Ex, O ₂ , H ₂ S LC 83 23 914 Dräger X-am 2500 Ex, O ₂ , CO 83 23 916 Dräger X-am 2500 Ex, O ₂ , CO, H ₂ S LC 83 23 918	
Basic instrument with selectable special calibrations, including a calibration certificate 83 23 900	
Power supply units: NiMH power pack T4 (type HBT 0000) 83 18 704 NiMH power pack T4 HC (type HBT 0100) 83 22 244 Battery holder ABT 0100 83 22 237 Alkaline batteries T4 (x 2) for alkaline power pack 83 18 708 Rechargeable battery and charging kit (contains NiMH power pack T4, charging module for Dräger X-am 1/2/5000 and plugin power pack) 83 18 785	
Chargers: Charging module for Dräger X-am 1/2/5000 83 18 639 Power pack with connecting cord (worldwide) for a maximum of 20 charging modules Dräger X-am 1/2/5000 83 15 805 Power pack (worldwide) for a maximum of 5 charging modules Dräger X-am 1/2/5000 83 16 994 Power pack (worldwide) for a maximum of 2 charging modules Dräger X-am 1/2/5000 83 15 635 Vehicle connecting line 12 V/24 V for Dräger X-am 1/2/5000 charging module 45 30 057 Vehicle installation set for 1 Dräger X-am 1/2/5000 charging module 83 18 779	
Accessories The accessories are not included in BVS10 ATEX E 080X and PFG 10 G 001X.	
Pump accessories: Dräger Pump X-am 1/2/5000 83 19 400 Case for Dräger Pump X-am 1/2/5000 83 19 385 Rubber ball pump 68 01 933 Manual pump adapter 83 19 195 Dust and water filter 83 13 648	

Name and description	Order no.
Extension hoses and probes: Measuring probe 0.5 m 64 08 238 Measuring probe 1.5 m 64 08 239 Plug-in telescopic probe 68 01 954 Telescopic probe 100 with accessories 83 16 530 Telescopic probe 150 stainless steel 83 16 533 Tester 90 83 16 532 Float probe with accessories 83 18 371 Viton hose 12 03 150 Hose 11 80 681	
Accessories for measured value acquisition and configuration: Dräger GasVision 83 14 034 USB DIRA with USB cable (USB infrared adaptor for communication Dräger X-am 1/2/5000 – PC) 83 17 409	
Calibration/adjustment accessories: Bump Test Station, including mixed gas cylinder 83 19 130 E-Cal module Dräger X-am 1/2/5000 83 18 754 Calibration cradle Dräger X-am 1/2/5000 83 18 752 Mixed gas cylinder 2.5 vol. % CH ₄ , 18 vol. % O ₂ , 15 ppm H ₂ S, 50 ppm CO 68 11 130 Test gas cylinder propane, 0.9 vol. % C ₃ H ₈ in air 68 11 118 On demand regulator 83 16 556 Standard regulator 68 10 397	
Other accessories: Protective case for Dräger X-am 1/2/5X00 83 21 506 Carrying bag 83 18 755 Spare parts DrägerSensor CatEx 125 PR, 0 to 100 %LEL 68 12 950 DrägerSensor XXS O ₂ , 0 to 25 vol. % ¹⁾ 68 10 881 DrägerSensor XXS CO, 0 to 2000 ppm ¹⁾ 68 10 882 DrägerSensor XXS H ₂ S LC, 0 to 100 ppm ¹⁾ 68 10 883 DrägerSensor XXS NO ₂ , 0 to 50 ppm 68 10 884 DrägerSensor XXS SO ₂ , 0 to 100 ppm 68 10 885	

1) Expected service life of the sensors: O₂ and CO >5 years, CatEx > 3 years.

13 Declaration of Conformity

EG-Konformitätserklärung
EC-Declaration of Conformity

Dokument Nr. / Document No. SE23158-00

Wir / we Dräger Safety AG & Co. KGaA, Revalstraße 1, 23560 Lübeck, Germany

 erklären in alleiniger Verantwortung, dass das Produkt
 declare under our sole responsibility that the product

Gasmessgerät Typ MQG 0011 (X-am 2500)
Gas Detection Instrument type MQG 0011 (X-am 2500)

 mit der EG-Baumusterprüfbescheinigung
 is in conformity with the EC-Type Examination Certificate

BVS 10 ATEX E 080 X

 ausgestellt von der benannten Stelle
 issued by the Notified Body

 DEKRA EXAM GmbH
 Dinnendahlstraße 9
 D-44809 Bochum

 Kenn-Nr. der benannten Stelle
 Identification Number of Notified Body

0158

 und mit den folgenden Richtlinien unter Anwendung der aufgeführten Normen übereinstimmt
 and with the following directives by application of the listed standards

Bestimmungen der Richtlinie provisions of directive	Nummer sowie Ausgabedatum der Norm Number and date of issue of standard
94/9/EG: ATEX-Richtlinie 94/9/EC: ATEX Directive	EN 60079-0:2009, EN 60079-1:2007, EN 60079-7:2007, EN 60079-11:2007, EN 60079-26:2007, EN 50303:2000, EN 60079-29-1:2007, EN 50271:2001
2004/108/EG: EMV-Richtlinie 2004/108/EC: EMC Directive	EN 50270:2006 (type 2), EN 61000-6-3:2007

 Überwachung der Qualitätssicherung
 Produktion durch
 Surveillance of Quality Assurance Production by

 DEKRA EXAM GmbH
 Dinnendahlstraße 9
 D-44809 Bochum

 Kenn-Nr. der benannten Stelle
 Identification Number of Notified Body

0158

Lübeck, 2013-01-14

 Ort und Datum (jjjj-mm-tt)
 Place and date (yyyy-mm-dd)

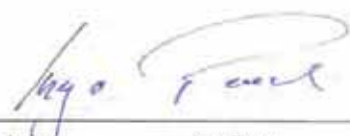
 Ingo Pooch
 Leiter
 Forschung & Entwicklung
 Gasmessgeräte

 Ingo Pooch
 Manager
 Research & Development
 Gas Detection Instruments

© **Dräger Safety AG & Co. KGaA**
Revalstraße 1
23560 Lübeck, Germany
Tel +49 451 882 0
Fax +49 451 882 20 80
www.draeger.com

90 33 366 - TH 4638.205
© Dräger Safety AG & Co. KGaA
Edition 01 - November 2012
Subject to alteration